

INSTRUCTION BOOKLET

**READ AND KEEP
THESE INSTRUCTIONS**

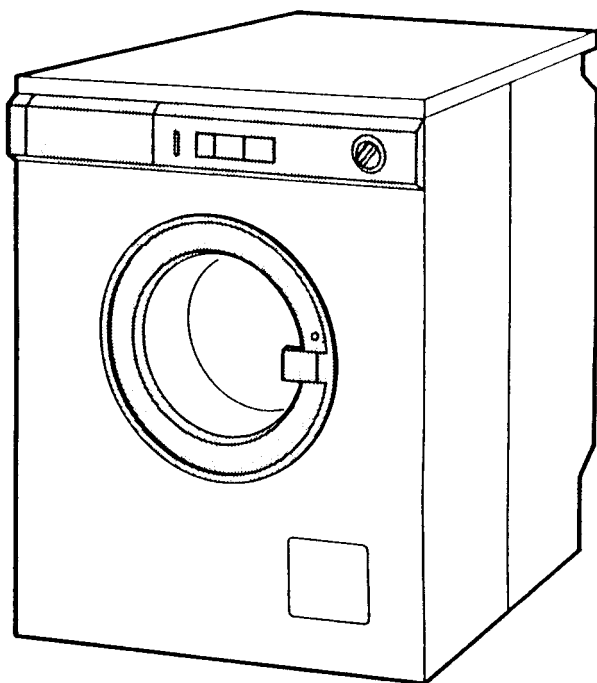

**WASHING MACHINE
FL 1032**

ZANUSSI

INDEX

Page 2	Technical specifications
Page 3	Warnings
Page 4	The control panel
Page 6	Your machine
Page 7	Installation instructions
Page 11	Use of controls
Page 14-15	The washing programmes
Page 16	Use of detergent and additives
Page 18	Washing 4 kg of white cotton at 95°C
Page 20	Washing 2 kg of delicate synthetic fabrics at 40°C
Page 22	Washing hints
Page 23	Maintenance
Page 24	Cleaning the filter
Page 25	Servicing
Page 32	Zanussi guarantee conditions
Page 33	5 Year cover

TECHNICAL SPECIFICATIONS

DIMENSIONS	Width	60 cm (23.6")
	Height	85 cm (33.5")
	Depth	57 cm (22.4")

ELECTRICAL CONNECTION	Voltage	220/240V - 50Hz
	Maximum power absorbed	2550 W (13A)

WATER PRESSURE	Minimum (hot)	5 psi
	Minimum (cold)	7 psi
	Maximum	110 psi

MAXIMUM RECOMMENDED LOAD	Cotton, linen	4.5 kg (10 lb)
	Synthetics, delicate fabrics	2 kg (4.5 lb)
	Wool	1 kg (2.2 lb)

SPIN SPEED	Maximum	1000 r.p.m.
------------	---------	-------------

This appliance conforms to the E.E.C. directive No. 87/308 of 2/6/87 regarding the suppression of radio interference.

WARNINGS

It is most important that this instruction book should be retained with the appliance for future reference. Should the appliance be sold or transferred to another owner, or should you move house and leave the appliance, always ensure that the book is supplied with the appliance in order that the new owner can be acquainted with the functioning of the appliance and the relevant warnings.

These warnings are provided in the interest of safety. You must read them carefully before installing or using the appliance.

- ▲ This appliance is designed to be operated by adults. Children should not be allowed to tamper with the controls or play with the product.
 - ▲ It is dangerous to alter the specifications or attempt to modify this product in any way.
 - ▲ Any electrical work required to install this appliance should be carried out by a qualified electrician or competent person.
 - ▲ Any plumbing work required to install this appliance should be carried out by a qualified plumber or competent person.
 - ▲ This product should be serviced by an authorized Zanussi Service Centre, and only genuine spare parts should be used.
 - ▲ Care must be taken to ensure that the appliance does not stand on the electrical supply cable.
 - ▲ Always unplug the appliance and turn off the water after use.
 - ▲ Do not overload the appliance. See relevant section in instruction book.
 - ▲ Always look through the glass door to check if water has drained before opening the door. If water is present do not open door before draining the water. If in doubt, refer to your instruction book.
 - ▲ This appliance is heavy. Care should be taken when moving it.
 - ▲ All packing and transit bolts must be removed before use. Serious damage can occur to the product and to property if this is not adhered to. See relevant section in instructions.
 - ▲ The glass door becomes very hot during the washing cycle. Keep children away from the vicinity of the appliance whilst it is in operation.
 - ▲ Leave the porthole door slightly ajar between washes to preserve the door seal.
 - ▲ Only wash fabrics which are designed to be machine washed. If in doubt, consult the manufacturer of that item.
 - ▲ Before washing, ensure that all pockets are empty and buttons and zips are fastened. Avoid washing frayed or torn articles and treat stains such as paint, ink, rust, and grass before washing. Underwired bras must not be machine washed.
 - ▲ Any objects such as coins, safety pins, nails, screws, stones or any other hard, sharp material can cause extensive damage and must not be placed into the appliance.
 - ▲ Before selecting a programme or changing an ongoing programme the machine must be switched off by depressing the ON/OFF push-button.
 - ▲ Garments which have been in contact with volatile petroleum products should not be machine washed. If volatile cleaning fluids are used, care should be taken to ensure that the fluid is removed from the garment before placing in the machine.
 - ▲ Wash small items such as socks, laces, washable belts etc in a washing bag or pillow case as it is possible for such items to slip down between the tub and the inner drum.
 - ▲ Only use the advised quantities of fabric softener. Damage to the fabric can ensue if you over-fill. Refer to the manufacturer's recommendations of quantities.
 - ▲ As some duvets and eiderdowns should be washed/dried in large commercial machines because of their bulk, please check with the manufacturer of the item before washing in a domestic machine, even if the dry weight of the item is within the limit advised.
 - ▲ Pets have been known to climb into washing machines. Please check your drum before use.
 - ▲ Under no circumstances should you attempt to repair the machine yourself. Repairs carried out by inexperienced persons may cause injury or more serious malfunctioning. Contact your local Zanussi Service Centre. Always insist on genuine Zanussi spare parts.
-

THE CONTROL PANEL

Keep this page open while reading the booklet

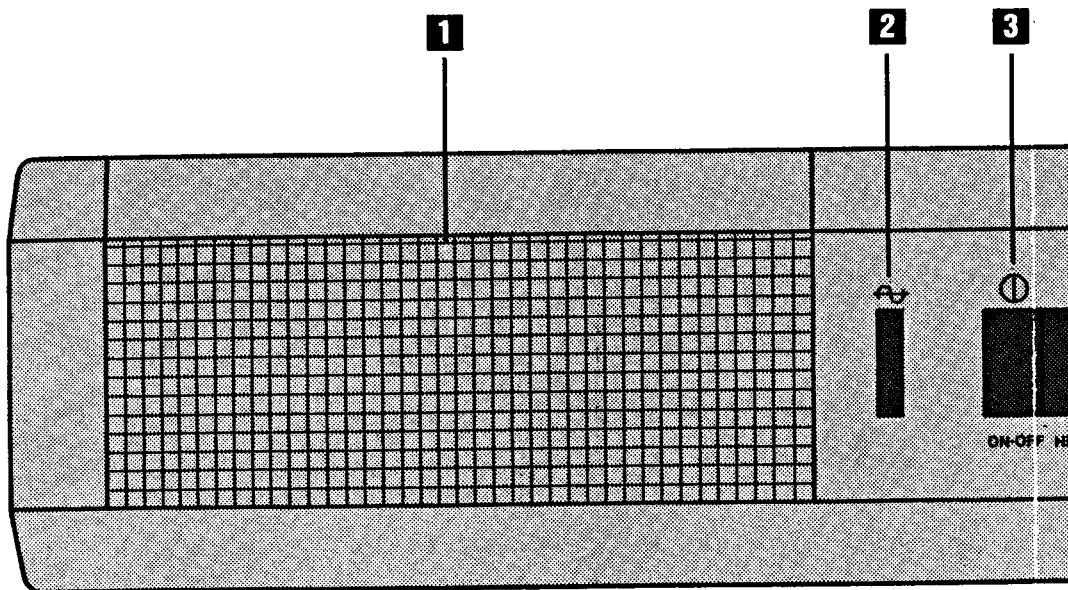

SYMBOLS

Symbols provided on the control panel have the following meaning:

 Pilot light

 Start/Stop button

 Heavy soil

 Half load

 Prewash compartment

 Wash compartment

 Softener compartment

 Wash

 Rinses

 Spin

 Drain

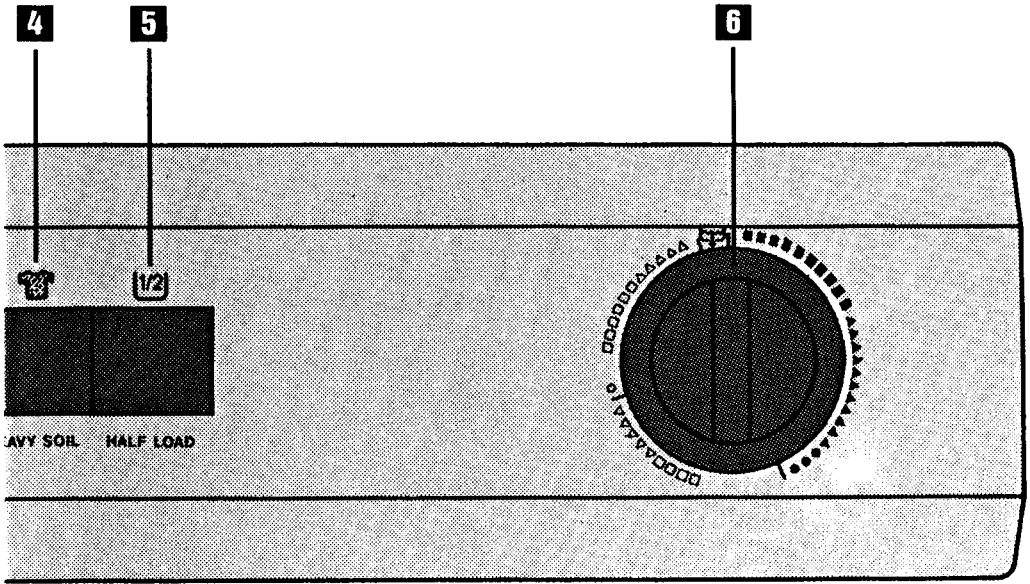

- 1** Programme chart
- 2** Pilot light
- 3** Start/Stop button
- 4** «Heavy soil» push button
- 5** «Half load» push button
- 6** Programme control

YOUR MACHINE

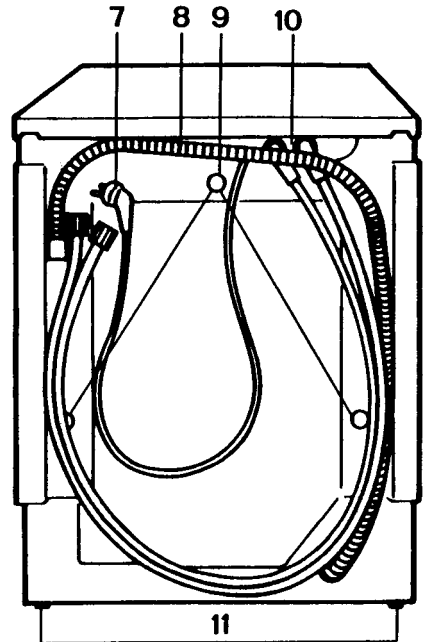
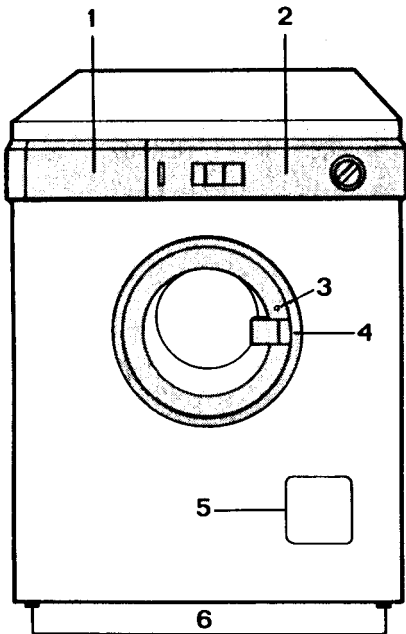

- 1 Washing powder dispenser drawer
- 2 Control panel
- 3 Door pilot light
- 4 Door catch
- 5 Drain Filter
- 6 Adjustable feet

- 7 Water inlet hoses
- 8 Mains lead with plug
- 9 Drain hose
- 10 Transport safety screws
- 11 Rollers

INSTALLATION INSTRUCTIONS

CAUTION

Before starting the machine up, the packing must be removed as follows.

NOTE

You are advised to keep all the packing for re-use in case the machine has to be transported again.

1

Unscrew and remove the rear right screw (using a screwdriver or spanner).

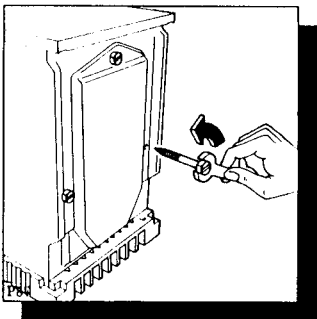

2

Lay the machine on its back making sure that the hoses are not squashed.

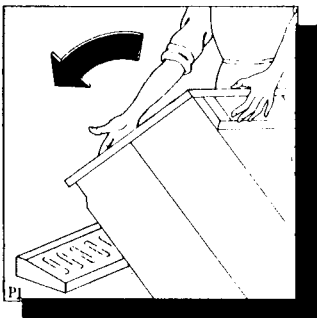

3

Remove the polystyrene block from the bottom of the machine.

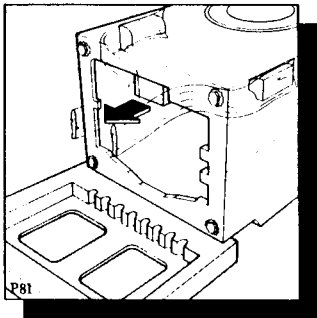

4

Carefully slide out the right polythene bag, removing it towards the centre of the machine.

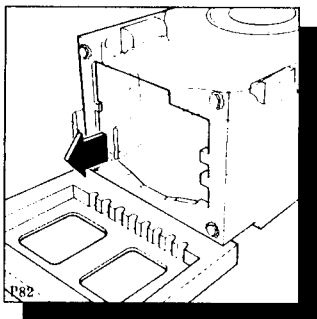

5

Repeat the operation for the left polythene bag, removing it towards the centre of the machine.

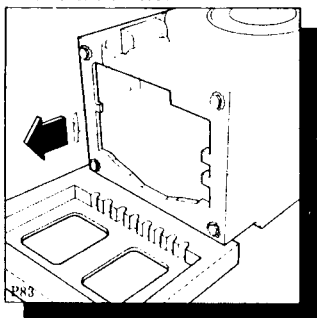

6

Remove the polystyrene base, set the machine upright and unscrew the two remaining rear screws.

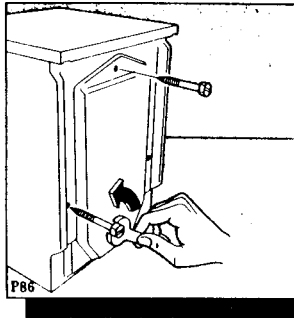

7

Slide out the 3 plastic pins.

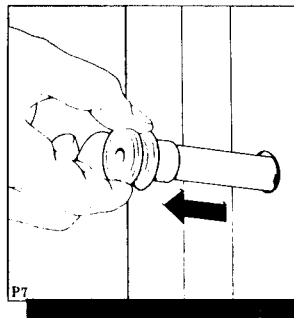

8

Plug the 3 holes with the 3 plastic plugs which you can find on the back of the machine or in the envelope containing the booklet.

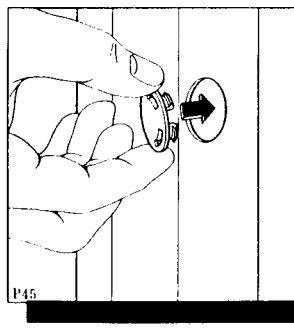

INSTALLATION INSTRUCTIONS

9

Your new Zanussi washing machine has been designed to be permanently plumbed in to your home's water supply and drainage system. However, if this is not possible, it may be connected to suitable existing taps, with the drain hose discharging into a sink.

The appliance has two inlet valves, hot and cold, with female 3/4" BSP thread connectors. If this connection size is not compatible with the plumbing of the existing installation, a variety of connectors are available from good hardware stores and plumbers merchants to suit most domestic plumbing. Any alterations to your existing plumbing must be carried out by a competent person, or qualified plumber.

10

The inlets on the back of the appliance are colour coded, blue for cold, red for hot.

Before connecting the hoses be sure to fit the mesh filters supplied as per diagram.

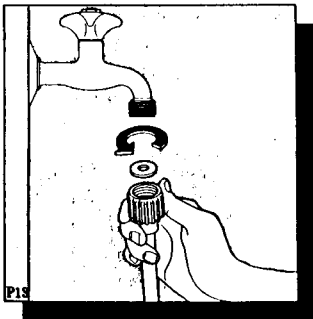

If only a cold water supply is available, connect the two hoses to a cold water outlet by means of a «Y» connection piece.

Installation should comply with local water authority and building regulations' requirements.

The appliance must be given a separate cold water supply and not be connected to a mixer tap, a single outlet water heater or a booster pump. A minimum water pressure of 7 psi is required for safe operation of the appliance.

If you cannot make the cold water connection direct from the rising mains, you may be able to operate the appliance from your cold water storage system.

There should be a minimum distance of 5.02 m (16½ ft) between the appliance's inlet and the bottom of the tank.

There will be sufficient pressure for the hot water supply from the hot water cylinder if the height between the appliance's inlet and the bottom of the cold water storage cistern (not between the appliance and hot water cylinder) is at least 2.74 m (9 ft).

11

Set the hoses correctly by loosening the ring nut. After positioning the inlet hoses be sure to tighten the ring nut again to prevent leaks.

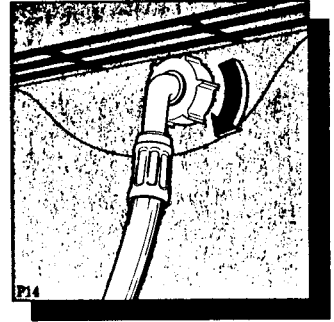

INSTALLATION INSTRUCTIONS

12

If you intend the drain hose from the machine to empty into a sink, make sure that the sink is empty and that the plug hole is not blocked.

If the machine is permanently plumbed in, hook the end of the drain hose into a standpipe installed for the purpose.

The standpipe must have an internal diameter of at least 30 mm (1 1/2 in), in order that there is an air gap between the drain hose and standpipe. Make sure, that it is designed in such a way, that the end of the drain hose cannot be covered with water.

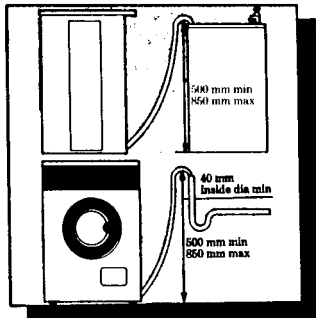

Important: Before connecting up the machine to new pipework or to pipework that has not been used for some time, run off a reasonable amount of water to flush out any debris that may have collected in the pipes.

Whether discharging into a sink or a standpipe check that the end of the drain hose is neither too high nor too low. The top of the curve in the hose's end should be no more than 90 cm (35.4") and no less than 60 cm (23.6") above floor level.

13

ELECTRICAL CONNECTION

WARNING:
THIS APPLIANCE
MUST BE EARTHED

The manufacturer declines any liability should this safety measure not be observed.

If the plug that is fitted to your appliance is not suitable for your socket outlet, it must be cut off and the appropriate plug fitted.

The cut off plug should be disposed of to prevent the hazard of electric shocks in case it should be plugged into a 13 Amp socket in another part of your home.

Important

The wires in this mains lead are coloured in accordance with the following code:

GREEN AND YELLOW	- EARTH
BLUE	- NEUTRAL
BROWN	- LIVE

If you fit your own plug, the colours of the wires in the mains lead of your appliance may not correspond with the markings identifying the terminals in your plug, this is what you have to do:

Connect the green and yellow (earth) wire to the terminal in the plug which is marked with the letter «E» or the earth \perp symbol or coloured green, or green and yellow.

Connect the blue (neutral) wire to the terminal in the plug which is marked with the letter «N» or coloured black.

Connect the brown (live) wire to the terminal which is marked with the letter «L» or coloured red.

The plug moulded on to the cord incorporates a fuse. For replacement, use a 13 Amp BS 1362 fuse.

Only ASTA approved fuses should be used.

The fuse cover/carrier must be replaced in the event of changing fuse.

The right fuse cover/carrier colour is the one shown by the coloured insert at the base of the plug.

The plug must not be used if the fuse cover/carrier is lost.

A replacement cover/carrier must be obtained from Zanussi Service Agents whose addresses are listed on the attached «Zanussi Service Force Directory» or you could find your local agent by looking in your telephone directory under "Z".

This appliance complies with E.E.C. directive no. 87/308 of 2.6.87 relative to radio interference suppression.

INSTALLATION INSTRUCTIONS

14

Level the washing machine by raising or lowering the feet. Accurate levelling prevents vibrations, noises and displacement of the washing machine during operation. After levelling the machine, secure the feet by tightening the ring nuts.

Some vibration is inevitable, especially if mounted on a wooden floor.

Sprung wooden floors are particularly susceptible to vibration. For advice, consult a builder. If possible, always place the machine on a solid floor.

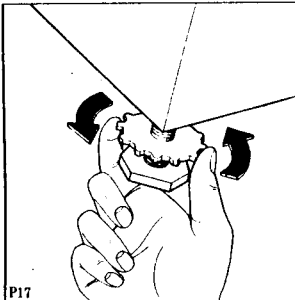

15

Special conditions

If the floor is carpeted with a deep-pile carpet or covered with crumbly or soft material, insert a rigid support base under the feet to prevent noises, vibrations or displacement. The base should protrude a few centimetres beyond the edges of the washing machine.

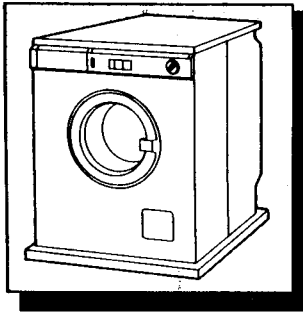

NOTE

Please ensure that when the appliance is installed it is easily accessible for the engineer in the event of a breakdown.

All plumbing and electrical work required to install this appliance must be carried out by competent persons or qualified plumbers or electricians.

USE OF CONTROLS

The user must be familiar with the machine controls and use them correctly for best washing results.

1

WASHING POWDER DISPENSER DRAWER

The washing powder and additives must be placed in this drawer before starting the programme.

There is also a brief guide to the washing programmes on the drawer itself.

2

PILOT LIGHT

This lights up when the start/stop button is depressed and goes out when the button is pressed again.

3

START/STOP BUTTON

By depressing this button the machine starts operating. When depressing it again, the machine stops.

The push button is provided with a child-proof safety lock.

Push the small slider placed on the button to lock it in the «off» position.

4

HEAVY SOIL BUTTON

By pressing the heavy soil button, the machine will take in cold water only on programmes with a water temperature of 60°C and hotter.

These would normally be hot and cold, or hot fill only.

The water is then gradually heated to the required temperature.

The effect is to improve the overall wash performance, particularly on biological stains such as egg, blood and grass stains, and heavily soiled fabrics, since the longer «cool-soak» phase as the water heats up provides the right conditions for the powder and the water temperature to interact, and achieve the best possible results.

5

HALF LOAD BUTTON

Press this button when washing a small cotton or linen load (max. 2.25 kg) to reduce water consumption: the number of rinses is reduced from 5 to 4.

6

PROGRAMME CONTROL

To select the required programme, press and turn this dial clockwise until the marker at the top of the dial coincides with the required programme letter.

HOW AND WHEN TO USE THE CONTROLS

START

After loading the laundry, place the washing powder and additives into the appropriate compartments. Before starting up the machine, check that:

- the appliance is plugged in
- the water supply taps are turned on
- the drain hose is correctly and securely positioned
- the door and the washing powder dispenser drawer are closed.

If required, press the half load and/or heavy soil button(s).

Select the required programme by pressing and turning the programme dial clockwise.

At this stage, press the «start/stop» button to start the programme up.

The pilot light comes on and the programme starts up.

STOP

When the programme has finished, the programme dial will be in the «I» position and the washing machine will automatically stop.

If you have selected a programme for synthetics, mixed fabrics, silk or wool, the water remaining in the wash tub must be drained by running the draining programme before opening the door.

Open the door only at the end of the programme when the pilot light beside the door catch goes out.

If necessary, stop the machine by pressing the «start/stop» button  again.

At the end of the programme, all the buttons should be reset to the «rest» position (not depressed).

THE WASHING

PROGRAMMES



















This washing machine has a wide range of programmes for optimum washing of all types of fabrics.

The differences between the programmes are the rotation rhythm of the drum, the washing temperature, the water level, use or not of the spin cycle etc.

Three special programmes are included in this washing machine; «worn once» is for very lightly soiled garments, giving a gentle, cool wash. «Hand rinses» is intended as a special rinse cycle to use after laundry has been washed by hand. «Freshen up» is a single rinse cycle to use for unsoiled laundry that may, for example, need rinsing to remove a stale smell, or to revive badly creased dry laundry.

The familiar wash code symbols which are found on the care labels in most clothes will gradually disappear and a new set of codes will be introduced. This change is due to changes in fabrics and detergents and

because people are tending to use fewer programmes and mix fabrics in one load. The change will bring the codes into line with the labelling used in the rest of Europe.











Old Symbol	New Symbol	Wash Action	Fabric
		Normal (Maximum)	White Cotton or Linen without Special Finishes
		Normal (Maximum)	Cotton, Linen or Viscose without Special Finishes Colourfast at 60° C.
	No longer used. White Nylon, Polyester/Cotton mixtures now included in		
		Reduced (Medium)	Nylon, Polyester/Cotton, Viscose with Special Finishes: Cotton/Acrylic Mix.
		Normal (Maximum)	Cotton, Linen or Viscose Colourfast at 40°C but not 60°C.
		Reduced (Medium)	Acrylics, Acetate, Triacetate, Wool mixes, Polyester/wool blends.
		Much Reduced (Minimum)	Wool, wool mixes. Silks.
	No longer used. Silk now included in  ; printed acetate included in  .		
	No longer used.		

The new symbols have been used on the Programme Guide of this machine, and are listed in the Programme Charts on page 14 and 15.

The new wash symbols will also appear on the side of Washing Powder packets.

PROGRAMMES FOR COTTON AND LINEN

Recommended load: max. 4.5 kg (10 lb)

PROGRAMME	DEGREE OF SOIL	COMPARTMENTS TO USE (☉ if required)	PROGRAMME DIAL POSITION	DESCRIPTION
 WHITES with prewash	Heavy soil		P	Prewash at 40°C Wash at 95°C 5 rinses Spin
 WHITES	Normal soil		A	Wash at 95°C 5 rinses Spin
 WHITES	Light soil		B	Wash at 60°C 5 rinses Spin
 FAST COLOURED	Normal soil		B	Wash at 60°C 5 rinses Spin
 NON - FAST COLOURED	Normal soil		C	Wash at 40°C 5 rinses Spin
LONG SPIN			D	Long spin approx. 5 min. Always preceded by a low-speed draining phase
SHORT SPIN			G	Short spin approx. 2 min. Always preceded by a low-speed draining phase

Water filling











30°/40°/50°C programmes - cold water filling

60°C programmes - hot and cold filling

95°C programmes - hot water filling only, unless the heavy soil button is used.

PROGRAMMES FOR SYNTHETICS, MIXED FABRICS SILK AND WOOL

Recommended load: max. 2 kg (4.5 lb); wool max. 1 kg (2.2 lb)

PROGRAMME	DEGREE OF SOIL	COMPARTMENTS TO USE (⊗ if required)	PROGRAMME DIAL POSITION	DESCRIPTION
 MIXED FABRICS	Normal soil		F	Wash at 50°C 3 rinses Stop with water left in drum
 DELICATES/ SYNTHETICS	Normal soil		H	Wash at 40°C 3 rinses Stop with water left in drum
 WOOL 	Normal soil		J	Wash at 40°C 3 rinses Stop with water left in drum
WORN ONCE	Light soil		K	Wash at 30°C 3 rinses Stop with water left in drum
HAND RINSES			L	3 rinses with additive if required Stop with water left in drum
FRESHEN UP			M	1 rinse with additive if required Stop with water left in drum
DRAIN			N	Draining of water

IMPORTANT! At the end of the last rinse, the washing machine stops without draining the water so that the garments do not crease. To drain the water, select programme **N** (draining).

USE OF DETERGENT AND ADDITIVES

Choosing the right washing powder. Always use a low lather powder. This is important as too much lather prevents the articles from being properly cleansed and you may damage the machine. **Ariel Automatic** is specially designed to complement the cleaning action of the machine.

USE OF WASHING POWDER

The washing powder should be placed in the appropriate compartments in the washing powder dispenser drawer before starting the programme.

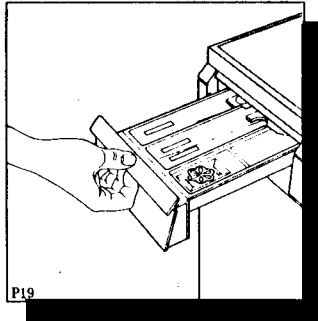

The compartment marked with the symbol **(I)** is for the prewash powder (if required by the programme).

The compartment marked with the symbol **(II)** is for the main wash powder.

The following table gives the quantities of washing powder to be used according to the hardness of the water.

Your local water authority will be able to tell you how hard your water is.

QUANTITIES OF WASHING POWDER IN GRAMMES OR MILLILITRES FOR A 4 KG LOAD		
Hardness of the water	Programmes with prewash (compartments (I) + (II))	Programmes without prewash (only compartment (II))
Soft: 0-7 degrees Clark	25 g + 110 g 50 ml + 220 ml	125 g 250 ml
Average: 7-14 degrees Clark	55 g + 135 g 110 ml + 270 ml	150 g 300 ml
Hard: 14-21 degrees Clark	80 g + 160 g 160 ml + 320 ml	180 g 360 ml
Very hard: Over 21 degrees Clark	100 g + 180 g 200 ml + 360 ml	195 g 390 ml

The quantities given apply to all washing powders except the concentrated type.

Reduce the quantity if:

- the load is small
- the laundry is lightly soiled
- an excessive amount of lather forms during washing

USE OF LIQUID

ADDITIVES

Any liquid additives for softening or dressing the laundry must be poured into the appropriate compartment of the washing powder dispenser drawer before starting the programme.

The compartment marked with the symbol  is for softeners and dressing agents; never exceed the MAX level.

USE OF LIQUID

DETERGENT

Suitable liquid detergent such as Ariel can be used instead of washing powder.

In this case a programme without prewash must be selected.

Pour the liquid detergent into the compartment  in the dispenser drawer immediately before starting the wash programme. If the detergent has its own dispenser ball, this should be used according to the manufacturer's instructions.

NOTE

Once the dispenser is filled, close it by pushing it in gently. This is particularly important if you are using fabric conditioner because if the drawer is slammed it will cause the conditioner to enter the machine prematurely.

WASHING 4 KG OF WHITE COTTON AT 95° C

Suppose you have 4 kg of normally dirty laundry to wash. It is white cotton and is suitable for high temperature washing.

1 LOAD THE LAUNDRY



Open the door by pulling the catch outwards. Load the items to be washed one at a time and close the door.

2 MEASURE OUT THE WASHING POWDER

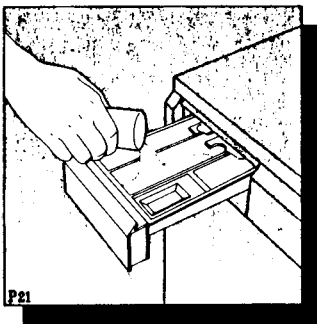

Following the table (page 16), measure the required quantity of washing powder and pour into the compartment **W**, the main wash compartment.

3 MEASURE OUT THE ADDITIVES

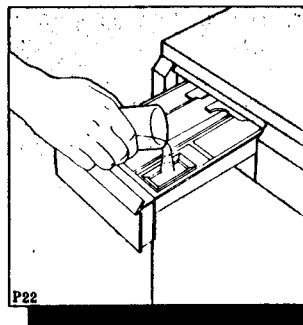

Pour the softener, if required, into the compartment marked **B**; do not exceed the MAX level. Close the drawer gently.

WASHING 4 KG OF WHITE COTTON AT 95° C

4

SELECT THE PROGRAMME

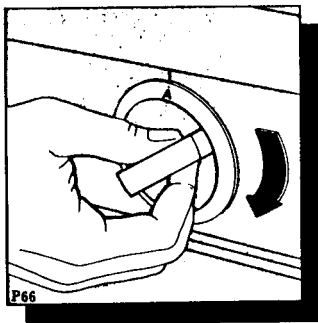

Press and turn the programme dial clockwise until letter **A** on the dial coincides with the red marker line.

5

START UP

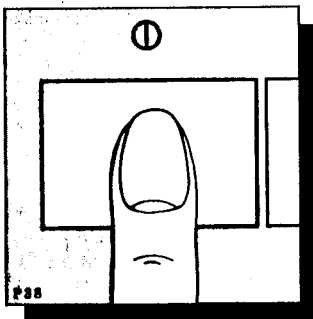

Check that:

- the appliance is plugged in,
- the water taps are on,
- the drain hose is correctly positioned.

Then push in the «start/stop» button .

The pilot lamp comes on and the washing machine starts to work.

6

AT THE END OF THE PROGRAMME

The machine automatically stops.

The door is controlled by a safety device which releases 1 - 2 minutes after the end of the programme.

Open the door only when the pilot light, which is situated next to the door handle, is off.

Push the «start/stop» button  again and the pilot lamp goes out.

When the programme has finished you are advised to unplug the appliance and turn off the water taps.

WASHING 2 KG OF SYNTHETIC FABRICS AT 40°C

Suppose you have 2 kg of synthetic fabric laundry to wash. They are rather delicate fabrics and should not be washed at a high temperature.

1

LOAD

THE LAUNDRY

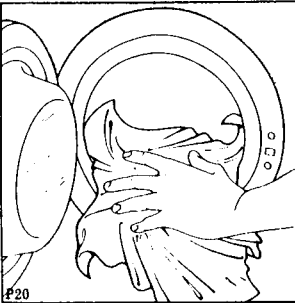



Open the door by pulling the catch outwards. Load the items to be washed one at a time and close the door.

2

MEASURE OUT

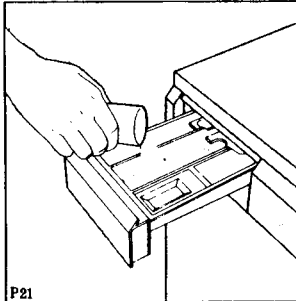
THE WASHING POWDER





Following the table (page 16), measure the required quantity of washing powder and pour into the compartment , the main wash compartment.

3

MEASURE OUT

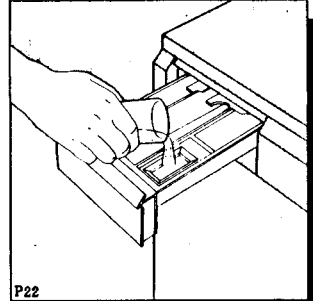
THE ADDITIVES



Pour the softener, if required, into the compartment marked ; do not exceed the MAX level.

Close the drawer gently.

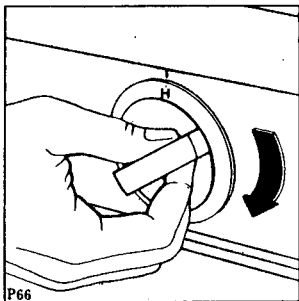
4**SELECT
THE PROGRAMME**

Press and turn the programme dial **clockwise** until letter **H** on the dial coincides with the red marker line.

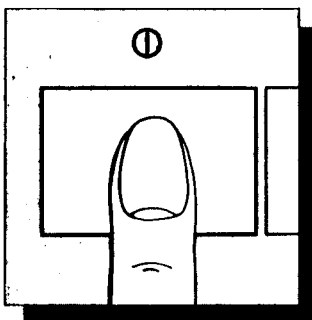
5**START UP**

Check that:

- the appliance is plugged in,
- the water taps are on,
- the drain hose is correctly positioned.

Then push in the «start/stop» button ①.

The pilot lamp comes on and the washing machine starts to work.

6**STOP WITH THE WATER
LEFT IN THE WASH TUB**

After the last rinse, the machine stops with the water left in the wash tub to avoid the laundry creasing.

Complete the programme by draining the water as follows:

- switch the machine off by depressing the «start/stop» button ① ;
- press and turn the programme dial **clockwise** to programme N (drain);
- push the «start/stop» button ① again.

7**AT THE END OF
THE PROGRAMME**

The machine automatically stops.

The door is controlled by a safety device which releases 1 - 2 minutes after the end of the programme.

Open the door only when the pilot light, which is situated next to the door handle, is off.

Push the «start/stop» button ① again and the pilot lamp goes out.

When the programme has finished you are advised to unplug the appliance and turn off the water taps.

WASHING HINTS

● Do not overload the washing machine. Weigh the laundry the first few times you use the washing machine.

The average weights of the most common items are listed below as a guide:

sheet	700-1000 gr.
pillow case	100- 200 gr.
tablecloth	400- 500 gr.
serviette	50- 100 gr.
tea towel	70- 120 gr.
linen hand towel	100- 150 gr.
towelling hand towel	150- 250 gr.
towelling bath towel	700-1000 gr.
bath robe	1000-1500 gr.
man's shirt	200- 300 gr.
apron	150- 200 gr.

● Load the laundry loosely alternating large items with small ones.

● Sort the laundry according to the type of fabric, colour-fastness and how dirty it is.

● Avoid washing unhemmed or torn items as they may unravel.

● Before washing, empty all pockets of small objects which may have been left inside (coins, keys, screws etc.).

● When washing curtains, remove the hooks.

● Close poppers and zips and fasten loose buttons.

● It is essential to wash new coloured items separately when washing them for the first time.

● When washing fabrics requiring different wash temperatures together, always select the lowest temperature.

● White items should not be washed with coloured items.

● Very small items (handkerchiefs, ribbons, socks etc.) should be washed in a washing bag.

● Use a good quality detergent suitable for automatic washing machines.

● Use the correct quantities of detergent.

● For wool, use gentle detergents only in small quantities.

● Bleach is very corrosive; it should be used with care and kept out of reach of children.

● Some stains such as fruit, wine, grass, rust etc. are difficult to remove and should be treated before washing with specific products which can be found in most household shops. In some cases it may help to soak the stain before washing with a special pre-soak product or biological detergent.

● Only wool marked «Pure New Wool - washable, preshrunk» can be washed in the machine using the wool programme; other types of wool should be washed by hand or dry cleaned.

● Damp laundry should be hung out to dry as soon as possible after finishing the wash.

Knitwear and woollens should be dried flat away from direct sunlight.

● Once you have finished using the machine, you are advised to unplug it and turn off the water tap.

MAINTENANCE

Successful washing and smooth running of your machine depend on a series of routine maintenance operations which should be carried out from time to time.

IMPORTANT

You are advised to unplug the appliance before all cleaning and maintenance operations.

DECALCIFICATION

The water we normally use contains lime. From time to time, and more often for hard water, it is a good idea to use a water softening powder in the machine. Do this separate to any laundry washing, and according to the softening powder manufacturer's instructions. This will prevent the formation of lime deposits.

AFTER EACH

WASH

Leave the door open for a while. This helps prevent mould and stagnant smells forming inside the appliance.

EXTERNAL CLEANING

Use soap and water only and then dry thoroughly.

CLEANING

THE DRAWER

From time to time the washing powder and additive dispenser drawer should be cleaned.

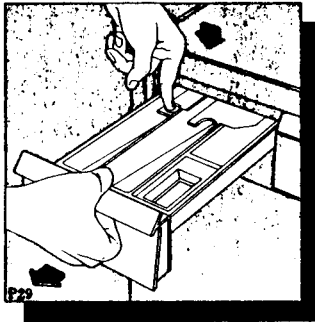

Remove the drawer and flush out under a tap.

The upper part of the additives compartment can be removed for easier cleaning.

CLEANING

THE DRAWER RECESS

Having removed the drawer, use a small brush to clean the recess ensuring that all washing powder residue is removed from the upper part of the recess. Replace the drawer and run the prewash (P) for a few minutes without any clothes and then the drain (N) cycle to clear any residues.

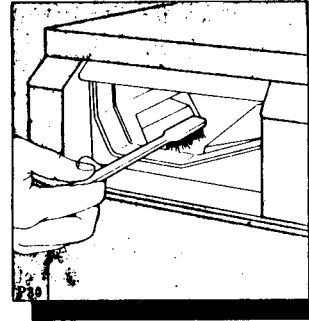

THE DANGERS OF FREEZING

If the machine is exposed to temperatures below 0°C, certain precautions should be taken.

- Turn off the water taps.
- Select a wash programme and run for a few seconds.
- Unscrew the inlet hoses.
- Unhook the drain hose from the rear support and position the end in a bowl. Run the draining programme for a few seconds.
- When you intend to start the machine up again, make sure that the room temperature is above 0°C.

CLEANING THE FILTER

THE WATER

DRAIN FILTER

A clean filter is important for correct functioning of the washing machine, and should therefore be cleaned after every wash.

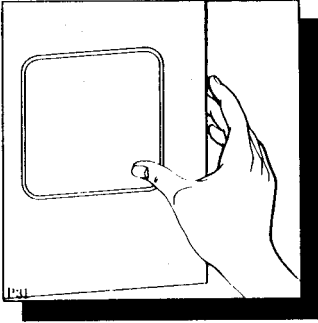

Open the panel covering the filter and place a container underneath to catch any spillage.

If the filter is blocked and the machine is unable to drain you will need to drain the water from the machine at this stage. To do this, unhook the drain hose from the standpipe or sink and hold the end of the hose over a bowl on the floor. The water should drain by gravity into the bowl. When the bowl is full, hook the hose back up and empty the bowl. Repeat the procedure until the water stops flowing out.

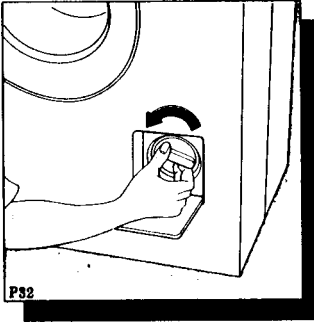

Unscrew the filter.

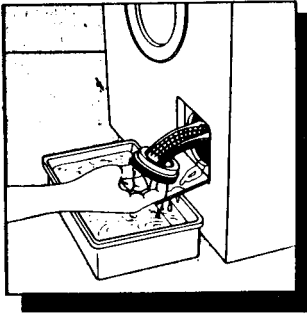

Remove the filter.

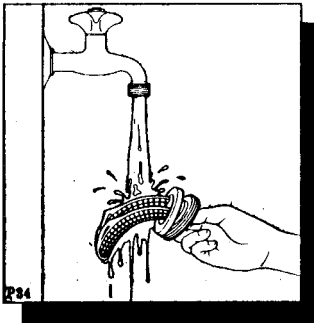

Clean carefully under a fast-running tap.

SERVICING

Certain problems are due to lack of simple maintenance or oversights and can be solved easily without having to call the Servicing Department.

■ PROBLEM	● CAUSE	▶ SOLUTION
THE MACHINE DOES NOT START UP (with pilot light off)	● The «start/stop» button is not pressed	▶ Press the «start/stop» button
	● The door is not closed properly. ● The appliance is not plugged in ● There is no electric supply from the wall socket	▶ Close the door ▶ Plug the appliance in ▶ Check the fuse.
(with pilot light on)	● The programming dial is not correctly positioned ● No water is entering the machine.	▶ Consult a qualified electrician ▶ Press and turn the programme dial to the selected programme ▶ See solutions to the problem: THE MACHINE DOES NOT FILL
THE MACHINE DOES NOT FILL	● The water tap is not on ● The water supply has been cut off. ● The inlet hose is bent ● The water pressure is too low	▶ Turn the tap on ▶ Wait until the water supply is restored ▶ Straighten the bend out ▶ If this occurs often, consult a qualified plumber
THE MACHINE EMPTIES AS IT FILLS	● The end of the drain hose is too low ● The end of the drain hose is submerged in water ● Drain pipe without vent-hole	▶ Position the drain hose at the correct height (between 60 and 90 cm) ▶ The end of the drain hose must NOT be submerged ▶ Consult a qualified plumber
THE MACHINE DOES NOT DRAIN OR SPIN	● You have selected a programme without a drain cycle ● The drain filter is clogged ● The drain hose is bent ● The drainage system pipes are blocked ● The drain hose extension is incorrect	▶ Run the draining programme ▶ Clean the filter before doing this ▶ Straighten the hose out ▶ Consult a qualified plumber ▶ Consult a qualified plumber

■ PROBLEM	● CAUSE	▶ SOLUTION
■ THE MACHINE LEAKS OR OVERFLOWS	● Too much washing powder	▶ Reduce the quantities of washing powder
	● Unsuitable washing powder	▶ Only use washing powder suitable for automatic machines
	● The inlet hose ring is loose	▶ Tighten the ring (see page 8)
	● The detergent dispenser drawer or recess are clogged	▶ Clean the drawer and recess (see page 23)
	● The end of the drain hose is not securely positioned	▶ Position the drain hose correctly
■ THE MACHINE VIBRATES OR IS NOISY	● The internal packing has not been removed	▶ Remove internal packing (see p. 7)
	● The machine is not level	▶ Adjust the feet (see page 10)
	● The machine is in contact with the wall or furniture	▶ Move the machine; it should rest freely on its feet
	● Washing load badly distributed	▶ Remember to shake out large items (e.g. sheets) when loading
	● The machine is overloaded	▶ Run the draining programme (N), reduce the load and continue
■ THE DOOR DOES NOT OPEN	● The safety device has locked it (door pilot light on)	▶ Wait 1 - 2 minutes after the end of the programme before opening the door (door pilot light off)
	● Water in the wash tub	▶ Drain the water by running the draining programme (N)

If, after the above checks, there is still a fault, call your nearest Zanussi Service Force Centre, whose address and telephone number can be found on the following pages.

Please make sure you give the model and serial number of the appliance. This information can be found on the rating plate (see picture), or on the guarantee certificate.

Original spare parts can be purchased from Zanussi Service Force Centres.

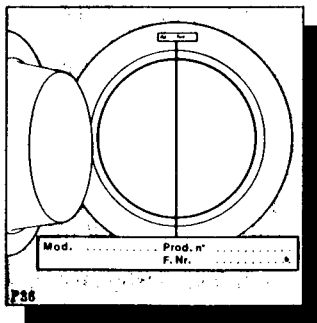

In-guarantee customers should ensure that the above checks have been made as the engineer will make a charge if the fault is not a mechanical or electrical breakdown.

Please note that proof of purchase is required for any in-guarantee service calls.

**How to find the telephone number of
your
Zanussi Service Force
listed in this leaflet**

Zanussi Service areas are allocated by postcodes which are listed in alphabetical order for easy reference.

1. Look for the two letters of your address postcode in the far left 'Postcode' column.
2. Match up the number of your postcode against the number listed in the 'Postcode Numbers' column.
3. Look across the column to the Service Force Key Number for your area. Turn to the last page of this directory for the address and telephone number to contact for service which is listed against your key number.

If you are unsure of your postcode, the main towns and cities are listed in alphabetical order for easy reference.

Additionally, your local Zanussi Service Force Centre telephone number is listed under 'Z' in your telephone directory.

The Customer Care Department at Zanussi House, Hambridge Road, Newbury, RG14 5EP, Tel: 0635 521313, will be happy to help you with any queries or difficulties.



Post-code Letter	Town	Post-code Number	Service Force Key Number	Post-code Letter	Town	Post-code Number	Service Force Key Number
AB	Aberdeen	1-5	1	DE	Derby	11-12	18
AL	St Albans	1-10	2	DG	Dumfries	1-7, 10-12	34
A	Brecon	45	3	DG		13-14	35
BA	Bath	1-5, 11-15	4	DG		8-9	36
BA		7-10, 20-22	5	DH	Durham	1-9	37
BA		6, 16	6	DL	Darlington	1-17	37
BB	Blackburn	1-12	7	DN	Doncaster	1-7, 10-12, 22	33
BD	Bradford	1-23	8	DN		14	38
BD		24	7	DN	Doncaster	8-9, 15-21, 31-40	39
BH	Bournemouth	1-18, 21-25	9	SUB POSTCODE DIVISION			
BH		19-20	10	DN	Gainsborough		
BL	Bury	0-9	11		South	21-1, 21-2, 21-5	40
BN	Brighton	1-9, 11-15,	12	DN	Gainsborough		
BN		20-27	12		North	21-3, 21-4	39
BN		16-18	13	DT	Dorchester	1-6, 10-11	10
BR	Bromley	1-8	14	DT		6-9	5
BS	Bristol	1-28, 98-99	15	SUB POSTCODE DIVISION			
BT	Belfast	1-82	16	DT	Bridport East	6-3, 6-4	10
B	Birmingham	1-21, 25-33,	17	DT	Bridport West	6-5, 6-6	5
B		38, 40, 45, 47-48,	17	DY	Dudley	1-6, 8-9	17
B		60-71, 80, 97-98	17	DY		7, 10-14	41
B	Birmingham	23-24, 34-37,	18	EC	London	All EC Codes	28
B		42-44, 46, 72-	18	EH	Edinburgh	1-42, 52-54	42
B		79	18	EH		43-46	35
B	Birmingham	49-50,	19	EH	Edinburgh	47-49, 51, 55	43
B		96	19	EN	Enfield	1-11	28
B	Birmingham	95	20	EX	Exeter	1-17, 20	45
CA	Carlisle	1-16, 18-28	21	EX		18-23, 31-39	46
CA		17	7	E	London	All East Codes	28
CB	Cambridge	1-8	22	FK	Falkirk	1-4	43
CB		9-11	23	FK		10-14, 18-19	32
CF	Cardiff	1-8, 31-48	3	FK	Falkirk	5-9, 15-17	47
CH	Chester	1-4	24	FK		20-21	31
CH		5-7	25	FY	Fleetwood	0-8	7
CH		8	26	GCI	Guernsey		48
CM	Chelmsford	0-6, 8-9, 11-15	27	GL	Gloucester	1-8, 10-19,	49
CM		7	23	GL		50-56	49
CM	Chelmsford	16-24	28	GL		9	15
CO	Colchester	1-16	23	GL		20	19
CR	Croyden	0, 2-4, 9	29	GU	Guildford	1-24, 26, 34-35	50
CT	Canterbury	1-21	14	GU		25	51
CV	Coventry	1-8, 10-12, 21-23,	20	GU	Guildford	27-33	13
CV		9, 13	18	G	Glasgow	1-5, 11-15, 20-23,	47
CV	Coventry	31-35, 37	20	G		31-34, 40-46, 51-	47
CV		36	19	G	Glasgow	53, 58, 60-69, 73,	47
CW	Crewe	1-12	30	G		76-78, 81-84	47
DA	Dartford	1-18	14	G	Glasgow	71-72, 74-75	43
DD	Dundee	1-5, 7-11	31				
DD		6	32				
DE	Derby	1-7, 13-15, 55	33				

Post-code Letter	Town	Postcode Number	Service Force Key Number	Post-code Letter	Town	Postcode Number	Service Force Key Number
HA	Harrow	0-9	52	L	Liverpool	1-49, 60-70	24
HD	Huddersfield	1-8	8	ME	Medway	1-20, 99	14
HG	Harrogate	1-5	8	MK	Milton Keynes	1-17, 19, 40-46	22
HP	Hemel	1-3	2	MK		18	65
HP	Hempstead	4-23	53	ML	Motherwell	1-12	43
HR	Hereford	1-2, 4, 6-9	49	M	Manchester	1-35, 60	11
HR		3, 5	54	NE	Newcastle -on-Tyne	1-49, 61-70, 88	66
HU	Hull	1-20, 55	38	NE		98-99	66
HX	Halifax	1-7	8	NE		71	35
IG	Ilford	1-11	28	NG	Nottingham	1-23, 25	33
IOM	Isle of Man		55	NG		24	40
IP	Ipswich	1-15, 30-31	56	NG	Nottingham	31-34	64
IP		16-27	57	NN	Northampton	1-7, 11-12	67
IP	Ipswich	28-29, 32-33	22	NN		8-10, 14-18	22
IV	Inverness	1-24, 26, 30-36,	58	NN	Northampton	13	65
IV		40-49, 51-56	58	NP	Newport	1-9, 44	3
IV	Inverness	25, 27-28	59	NR	Norwich	1-35	57
JCI	Jersey		60	NW	London	All NW Codes	52
KA	Kilmarnock	1-26, 28-30	43	N	London	All N Codes	28
KA		27	61	OL	Oldham	1-12, 15-16	11
KT	Kingslon-on-Thames	1-23	51	OL		13-14	7
KT		24	50	OX	Oxford	1-17	65
KW	Wick	1-14	59	PA	Paisley	1-4	47
KW		15-17	62	PA		5-19	43
KY	Kirkcaldy	1-16	32	PA	Paisley	20-27, 33, 35, 40-	68
LA	Lancaster	1-23	7	PA		49	68
LD	Llandrindod	1-8	54	PA		28-31	69
LD		3	3	PA	Paisley	32, 34, 36-39, 61	70
LE	Leicester	1-5, 7-8, 11-14,	63	PA		62-78	68
LE		16-17	63	PA	Paisley	80-82, 88	71
LE	Leicester	6, 9-10	63	PA		83-87	72
LE		15	64	PE	Peterborough	1-15, 34, 38	64
LL	Llandudno	11-15	25	PE		16-19	22
LL		16-19	26	PE	Peterborough	20-25	40
LL	Llandudno	20-21, 23, 27, 31-	25	PE		30-33, 35-37	57
LL		32, 34-40, 42-47	25	PH	Perth	1-2, 8-9, 10-18	31
LL	Llandudno	22, 24-26, 28-30,	26	PH		3-7	32
LL		33-34, 41, 48-49,	26	PH	Perth	19-26, 30-44	58
LL		51-78	26	PL	Plymouth	1-21	73
LN	Lincoln	1-6, 8-10	40	PL		22-35	74
LN		7, 11-13	39	PO	Portsmouth	1-22	13
				PO		30-41	75
SUB POSTCODE DIVISION				PR	Preston	1-9	7
LN	Lincoln	3-4, 3-5	40	RG	Reading	1-17, 26	53
LN		3-6	39	RG		21-25, 27	50
				RG	Reading	28	4
LS	Leeds	1-29	8	RH	Redhill	1-3, 6-7, 9-20	12
LU	Luton	1-6	2	RH		4-5	50
LU		7	22	RH	Redhill	8	29

Post-code Letter	Town	Postcode Number	Service Force Key Number	Post-code Letter	Town	Postcode Number	Service Force Key Number
RM	Romford	1-5, 7, 10-18	27	TR	Truro	1-27	74
RM		6, 8-9	28	TS	Stockton-on-		
SA	Swansea	1-20, 31-32	3		Tees	1-29	37
SA		33-39, 41-44, 61-73	76	TW	Twickenham	1-20	51
SA	Swansea	40, 45-48	77	UB	Uxbridge	1-10	52
SE	London	All SE Codes	29	WA	Warrington	1-5, 8-9, 10-15	11
SG	Stevenage	1-9, 11, 15	2	WA		6-7	24
SG		10, 12-14	28	WA	Warrington	16	30
SG	Stevenage	16-19	22	WC	London	All WC Codes	52
SK	Stockport	1-3, 6-12	30	WD	Walford	1-2, 4-7	2
SK		4-5, 13-16	11	WD		3	53
SK	Stockport	17	33	WF	Wakefield	1-17	8
SL	Slough	1-10	53	WN	Wigan	1-5, 7	11
SM	Sutton	1-3, 7	51	WN		6, 8	24
SM		4-6	29	WR	Worcester	1-14	19
SN	Swindon	1-8, 11-16	65	WR		15	41
SN		9-10	4	WS	Walsall	1-15	18
SO	Southampton	1, 4, 41-43, 51	9	WV	Wolverhampton	1-4, 10-14	18
SO		2-3, 5, 21-24, 52	13	WV		5-9, 15-16	41
SO	Southampton	20	4	W	London	All West Codes	52
SP	Salisbury	1-5, 9-11	4	YO	York	1-3, 5, 7-8	8
SP		6	9	YO		4, 6, 11-18, 25	38
SP	Salisbury	7-8	10	YO	York	21-22	37
SR	Sunderland	1-7, 9	66	ZE	Lerwick	1,3	79
SR		8	37	ZE		2	80
SS	Southend-on-Sea	0-9, 11-17, 99	27				
ST	Stoke-on-Trent	1-18, 20-21	30				
ST		19	18				
SW	London	All SW Codes	52				
		Except 2, 9, 16					
SW	London	2, 9, 16	29				
SY	Shrewsbury	1-6, 9-17, 18-22	25				
SY		7, 17-19	54				
SY	Shrewsbury	8	41				
SY		23-25	77				
S	Sheffield	1-19, 30-31, 40-45,	33				
S		60-66, 74, 80-81	33				
S	Sheffield	70-73, 75	8				
TA	Taunton	1-11, 21-24	6				
TA		12-20	5				
TD	Selkirk	1-15	35				
TF	Telford	1-8, 10-13	41				
TF		9	30				
TN	Tonbridge	1-2, 4, 8-18, 23-30	14				
TN		3, 5-7, 19-22, 31-40	12				
TQ	Torquay	1-6, 9, 12-13	78				
TQ		7-8	73				
TQ		14	45				

Service Force Key Number	Service Force Address	Telephone Number	Service Force Key Number	Service Force Address	Telephone Number
1	60 Commerce Street, Aberdeen, AB2 1BP or Tel:	0224 583949 0224 582704	41	1 Underhill Street, Bridgnorth, Salop, WV16 4BB	0746 763322
2	Unit 4, Riverside Est, Coldharbour Ln, Harpenden	05827 461905	42	38 Buccleuch Street, Dalkeith, Midlothian, EH22	031 663 7758
3	3 Pentwyn Road, Blackwood, Gwent, Sth Wales	0495 223151	43	Block 2 Unit 5, Auchenraith Ind. Est. Rosendale Way, Blantyre	0698 828145
4	31 St Andrews Road, Bemerton, Salisbury, SP2	0722 336072	45	91 Exeter Road, Exmouth, Devon, EX8 1QD	0395 263531
5	31 East Street, Crewkerne, Somerset, TA18	0460 72740	46	3 Bear St. Barnstaple, North Devon, EX32	0271 71774
6	80 Killigrew Street, Falmouth, Cornwall, TR11	0984 31858	47	Unit E6C Anniesland Ind. Est. Netherton Rd, Glasgow, Scotland or Tel:	041 954 5304 041 954 5349
7	333 Ranglet Road, Walton Summit, Preston, PR5	0772 321200	48	Blencathra, Saumarez Lane, Castel, Guernsey	0481 56854
8	7 Crown Street, Leeds, Yorks, LS2	0532 460992	49	134 Eastgate Street, Gloucester, GL1 1QT	0452 422488
9	63 Curzon Road, Bournemouth, BH1 4PW	0202 303363	50	Unit 1 Redfields Ind. Pk, Church Crookham, Fleet	0252 851414
10	Poundbury Road, Dorchester, Dorset, DT1 2PJ	0305 264951	51	127 Walton Road, Molesey, Surrey, KT8 0DT	081 979 6366
11	Unit 41/42 Clarendon Ct, Winwick Quay, W'ton	0925 50822	52	27 Christchurch Ind. Est. Forward Drive, Harrow	081 427 4247
12	Sydney House, Queens Road, Haywards Heath	0444 417656	53	Reform Road, Maidenhead, Berkshire	0628 783711
13	266 Main Road, Southbourne, Emsworth, PO10 or Tel:	0243 374814 0243 371170	54	Merion House, High Street, Liandrindod Wells	0597 4842
14	Bridgewood Hse, 8 Laker Road, Rochester, ME1 or Tel:	0634 201441 0689 61444	55	Tromode Wks, Cronkbourne Vill, Douglas, I.O.M.	0624 76066
15	89 Stoke Croft Road, Bristol, Avon, BS1 3RD or Tel:	0272 246271 0272 246378	56	Unit 2b, Elton Park Business Centre, Hadleigh Rd, Ipswich, IP2 0DQ	0473 211713
16	Owenmore Hse, Kilwee Ind. Est., Upper Dunmurry Lane, Belfast	0232 301121	57	75 Grove Road, Norwich, NR1 3RL	0603 629653
17	66 Birch Rd East, Wyreley Rd Ind. Est, B'ham	021 327 1671	58	Unit 3B3, Smithton Ind. Est. Smithton, Inverness	0463 791822
18	Unit 3 Sterling Park, Claymore, Tamworth or Tel:	0827 289800 0827 289822	59	Main Street, Golspie, Sutherland, KW10 6RA	040 833517
19	22 Newton Road, Malvern, Worcester	0684 572915	60	P.O.Box 45, Queens Road, St Helier, Jersey	0534 67001
20	Unit 3, Bryant Road, Exhall, Coventry	0203 644277	61	Bruach, Blackwaterfoot, Isle of Arran	077 086 246
21	High Ehsenside, Egremont, Cumbria, CA22	0946 820509	62	Hatson Ind. Estate, Kirkwall, Orkney	0856 5457
22	1 Wharf Road, Higham Ferrers, Northants	0933 317727	63	30a Sootland Road, Market Harborough, LE16	0858 33229
23	Unit 18, Fourth Ave, Bluebridge Ind. Est, Halstead, Essex	0787 473982	64	Pinfold Rd, Manning Rd Ind. Est. Bourne, Lincs	0778 422147
24	Unit 14, Dock Road, Birkenhead, L41 1JJ	051 639 1287	65	Unit E19, Telford Rd, Launton Ind. Est. Bicester	0869 248598
25	Plas Fynnon W/house, Middleton Rd, Oswestry	0691 652917	66	Unit C1, Bergen Cl, Tyne Tunnel Trad. Estate, North Shields, Tyne & Wear	091 2960166
26	Easy Launderette, Panton Hall, Denbigh, Clwyd	074 571 3272	67	53 Sandringham Road, Northampton, NN1 5NA	0604 37061
27	19 Sirdar Rd, Off Brook Rd, Rayleigh, Essex	0268 741171	68	96 Argyll Street, Dunoon, Argyll, PA23 7NE	0369 2147
28	284 Alma Road, Enfield, EN3	081 805 6825	69	43 Crosshill Avenue, Cameltown, Argyll	0586 52008
29	194 Court Road, Eltham, London, SE9 4EN	081 859 3939	70	Strathblayne, Miller Road, Oban	0631 62690
30	Unit 8b, Alderflat Dr, Newstead Ind. Est. Stoke-on-Trent, ST4 8HX	0782 643814	71	2 Killweivagh, Gregory, Benbecula, Outer Hebrides	0870 2331
31	3-7 Blackness Street, Dundee, Scotland, DD1 or Tel: or Tel:	0382 642828 0382 455862 0382 826809	72	Churchouse, 16 James St, Stornaway, Isle of Lewis	0851 5555
32	33a Burnside, Auchtermuchty, Fife, Scotland	0337 28807	73	6 Embankment Ln, Embankment Rd, Plymouth	0752 222540
33	Unit 63, Stortforth Ln Trad. Est. Chesterfield	0246 231790	74	80 Killigrew Street, Falmouth, Cornwall, TR11	0326 314600
34	93 Irish Street, Dumfries, Scotland	0387 69694	75	109-111 Hunnyhill, Newport, Isle of Wight	0983 523062
35	2-8 Wood Market, Kelso, Borders, TD5 7AX	0573 24411	76	Roch, Haverfordwest, Dyfed	0437 710366
36	27 Antrim Ave, Stranraer, Dumfries & Galloway	0776 3277	77	4 Market Street, Aberaeron, W. Wales, SA46	0545 570254
37	8 Cumbie Way, Aycliffe Ind. Est. Newton Aycliffe	0325 300606	78	250-252 Torquay Road, Preston, Paighton	0803 526222
38	Unit 1, Boulevard Unit Fact. Est. Hull, HU3 4AY	0482 223335	79	3-4 Carlton Place, Lerwick, Shetland, ZE1	0595 2915
39	Unit 2, Cromwell Road, Grimsby, DN31 2BN	0472 358760	80	Harlsdale, Symbister, Whalasaay, Shetland	08066 546
40	Unit 14 Stonefield Park, Clifton Street, Lincoln	0522 537330			

PEACE OF MIND FOR TWELVE MONTHS

Zanussi Standard Guarantee Conditions

This guarantee is in addition to your statutory and other legal rights which will not be excluded or in any way diminished by the return of this guarantee card.

We, Zanussi Ltd., undertake that if within twelve months of the date of the purchase this ZANUSSI appliance or any part thereof is proved to be defective by reason only of faulty workmanship or materials, we will, at our option repair or replace the same **FREE OF ANY CHARGE** for labour, materials or carriage on condition that:

- * The appliance has been correctly installed and used only on the electricity supply stated on the rating plate.
- * The appliance has been used for normal domestic purposes only, and in accordance with the manufacturer's operating and maintenance instructions.
- * The appliance has not been serviced, maintained, repaired, taken apart or tampered with by any person not authorised by us.
- * The appliance is still in the possession of the original purchaser.

All service work under this guarantee must be undertaken by a Zanussi Service Force Centre. Any appliance or defective part replaced shall become our property.

EXCLUSIONS

This guarantee does not cover:

- * Damage or calls resulting from transportation, improper use or neglect, the replacement of any light bulbs or removable parts of glass or plastic.
- * Costs incurred for calls to put right machines improperly installed or calls to machines outside the United Kingdom.
- * Appliances found to be in use within a commercial environment, plus those which are the subject of rental agreements.

* Products of Zanussi manufacture which are NOT marketed by Zanussi Ltd.

* EEC Countries - the standard guarantee is applicable but is subject to the owner's responsibility and cost to ensure the appliance meets the standards set by the country to which the product is taken. The Zanussi company in the country concerned will be pleased to advise further. Sight of your purchase receipt will be required by them.

... OR FIVE YEARS

ZANUSSI 5 YEAR

COVER CONDITIONS

For a once-only payment you can extend your Standard Guarantee to 5 years.

All the conditions and exclusions of the Standard Guarantee apply.

NOTES

1. Products supplied as "seconds", refurbished, damaged, or shop-soiled are not eligible for Zanussi 5 Year Cover.
2. The issue of a cover does NOT by virtue of our having done so, nullify the exclusions.
3. The Engineer will need to check the details of your Cover card and may make a charge for his services if it is not presented to him at the time of his call.
4. The date of purchase, or the date of initial payment (deposit) of the appliance will be deemed the date of commencement of cover.
5. Covers issued are not refundable or transferable.

GUARANTEE RECORD

Appliance purchased from..... on.....

Guarantee card no Model no.....

Serial no. (These details may be taken from your Guarantee Record Card)

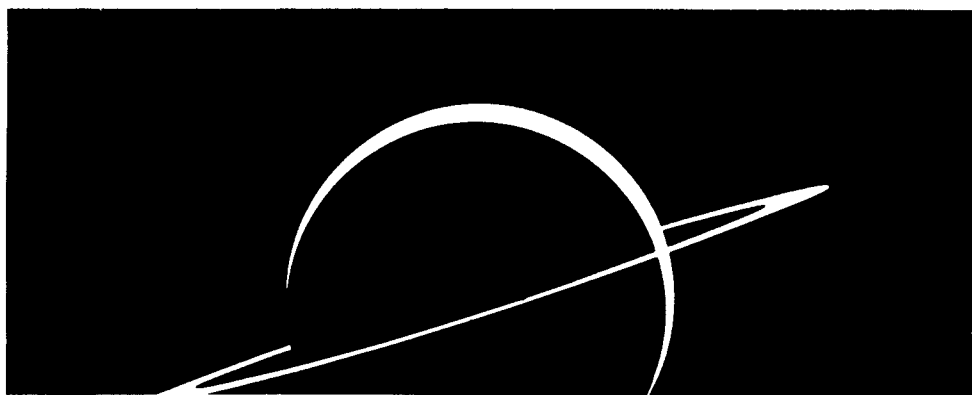

ZANUSSI

The appliance of science

Zanussi Ltd., Zanussi House, Newbury

The information in this manual is correct at time of going to press.
Zanussi reserve the right to alter specifications without notice.